

Mermaid™

Designer bathroom panels that fit right in



Installation Guidelines

REQUIRED TOOLS AND MATERIALS

Mermaid Panels Installation

TOOLS

- Pencil
- Drill
- Hole Saw (woodworking)
- Circular Saw
- Minimum 48 tooth carbide saw blade
- Chalk-Line
- Tape Measure
- Heavy Duty Caulking Gun
(Ideal for knife-grade adhesives/battery powered optional)
- Level
- Square

MATERIALS

- Denatured Alcohol

INCLUDED MATERIALS

- Mermaid Panels Adhesive
- Mermaid Panels Color Coordinated Sealant

PERSONAL PROTECTIVE EQUIPMENT RECOMMENDATION

- Dust Mask
- Safety Goggles
- Protective Gloves
- Protective Footwear

OPTIONAL TOOLS

- Router
- Suction Cups
- Jigsaw
- 1/2" shank - 2-flute router bit
- Battery powered caulking gun

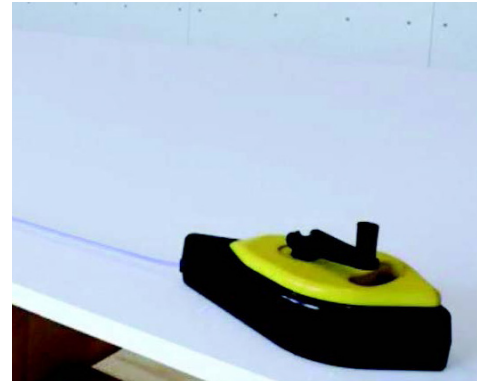

PREPARATION Memaid Panels Installation

STORAGE

- As with any laminate product, Wilsonart Memaid Panels should be stored flat in a controlled, moderate climate.
- Avoid storing in excessive heat/humidity extremes.
- All materials should be acclimated for a minimum of 48 hours before Installation/Fabrication.
- Material should not be stored near exterior doors that may result in exposure to rain or temperature/humidity variations

BEFORE YOU BEGIN

To ensure this product is installed properly, please read these instructions carefully before you begin. (Certain installations may require professional help.) Be sure your installation conforms to local codes.

- Local building codes vary by location. Observe all local plumbing and building codes.
- Unpack the Mermaid panels and inspect them carefully for damage. Verify that the walls are the correct size for your installation. Refer to Mermaid Technical Data sheet for specific dimensions for each model.

NOTE: Illustration 1 In handling the front surfaces of the panels. Use only non-abrasive cloths to avoid scratching.

PREPARATION

Must be installed over GREENBOARD, CEMENT/CONCRETE or TILE. SHEETROCK can be used in non-wet areas.

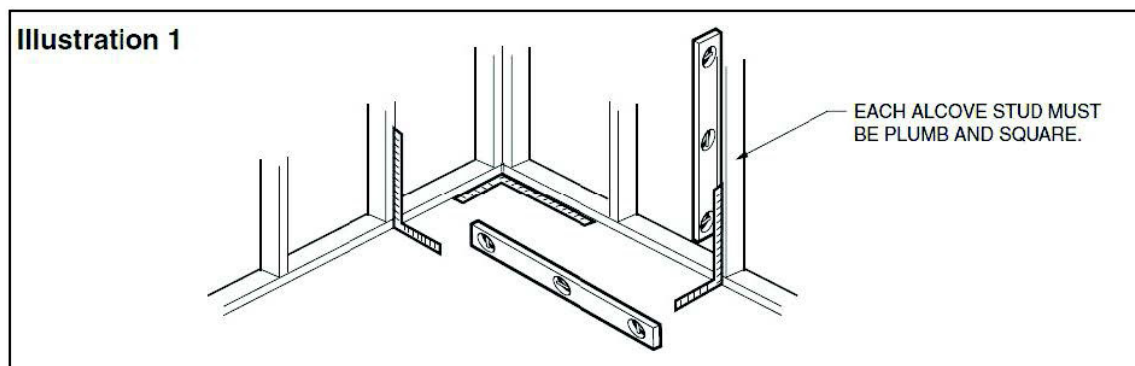

EXISTING WALL SURFACE PREPARATION

- Ensure wall surface is dry, smooth, and free of dust, soap scum, mold or other contaminants. Wipe wall surfaces with a damp cloth and allow to dry.
- Wall surface must be dry before panels can be applied.
- Ensure that alcove is plumb and square. (See Illustration 1)

ROUGH PLUMBING & FITTING

- Turn off hot and cold water supplies.
- Remove faucet handles, escutcheons, filler spouts and any other fixtures. (e.g. towel bars, soap dishes).
- Use a hammer and chisel to remove objects cemented to walls.

INSTALLATION OVER OLD TILE

- Old ceramic tiles, if solidly adhered to walls, need not be removed. Loose ceramic tiles must be removed and sub walls sanded smooth.
- Rough up glossy tile surfaces using belt sander with 60-grit sandpaper.
- Surface must be dry, smooth and free of any dust or any other contaminants.
- Wipe wall surfaces with a damp cloth and allow to dry.

IF YOU PLAN TO INSTALL A SHOWER DOOR

- Follow manufacturer's instructions and prepare stud wall accordingly.

DRY FITTING TONGUE AND GROOVE

Mermaid Panels Installation

STEP 1

Dry fit the panels starting with the rear most panels first. Keep a 1/8" (3mm) gap from the tub deck, shower base and from walls. Mark seam or joint location with a pencil on the wall (drywall) to be used later for panel adhesive reference.

- When installing multiple panels together the groove profile should be installed first. This allows the second panel with the tongue profile to fit easily into place. (See Illustration 2)

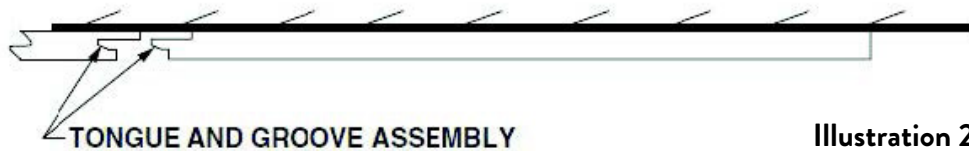

- Unpack the Mermaid panels and inspect them carefully for damage. Verify that the walls are the correct size for your installation. Refer to Mermaid Technical Data sheet for specific dimensions for each model.
- Suction cups will aid in the handling and installation of the wall panels. They will also aid in drawing seams together during the installation.

STEP 2

- Dry fit the two side panels next.
- On one side of the panel is a finished or reveal edge that can be installed on the outside or entrance edge of the shower to give a finished look not requiring standard wall trim. (See Illustration 3)
- If the wall or tub is out of square, trim or cut from bottom edge of side panels so that the top edge of the panels are level with the top edge of the back panels. Ensure saw blade is always cutting into the face of the decorative laminate.

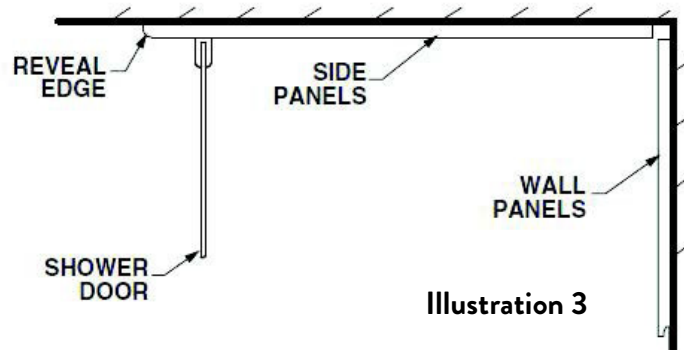

STEP 3

- Once both side panels are properly dry fitted, mark all plumbing locations where shower valves or shower heads come through the side panel.
- Drill holes at each location using a hole saw large enough to accommodate the opening but small enough to be covered by the trim plates.
- Drill from the decorative side. (See Illustration 4)

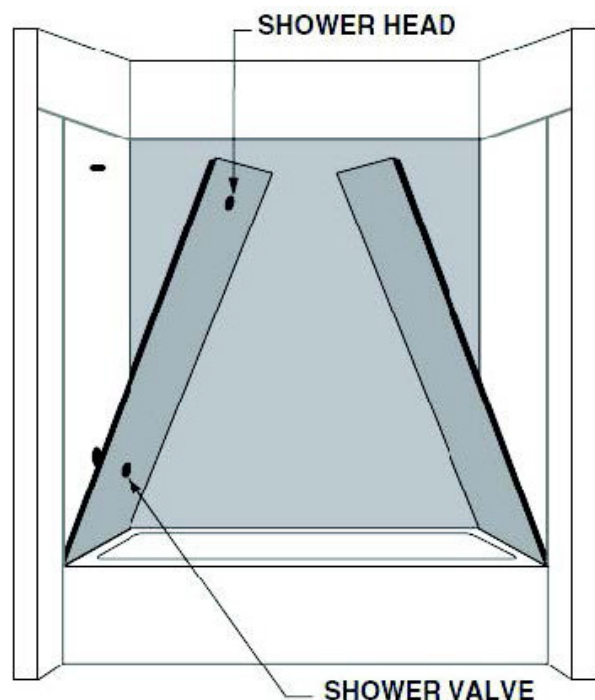

Illustration 4

PANEL ADHESIVE APPLICATION

Mermaid Panels Installation

Applying Panel Adhesive To Approved Subwall and Tongue and Groove Panels

NOTE: Do only one panel at a time.

STEP 1

- Wipe all back sides of panels and walls with a damp cloth to remove any dust or debris and allow to fully dry.

STEP 2

- Starting with the rear or back panels, apply panel adhesive on the wall (approved drywall) starting with an adhesive bead being applied 1 ½" (38mm) from each edge of each separate panel location. (See Illustration 5). Apply one row of panel adhesive horizontally across the top and bottom each ½" (13mm) from the edge.
- For each panel apply additional panel adhesive beads evenly spaced between the first two beads at approximately 10"– 12" (250-304mm) apart.
- Panel adhesive beads must be approximately ¼" (5mm) wide and deep in size.
- 49" width or larger panels will have a total of 6 panel adhesive beads equally spaced.
- 31" to 47" width panels will have a total of 5 panel adhesive beads equally spaced.
- 30" width or less panels will have a total of 4 panel adhesive beads equally spaced.

NOTE: Use of a heavy duty caulking gun is recommended for knife grade adhesives. Do Not Allow Panel Adhesive Beads To Connect or Overlap.

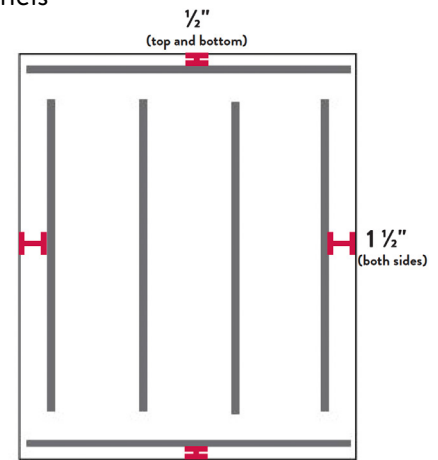

Illustration 5

STEP 3

- With the aid of suction cups, move first rear panel onto the wall keeping a space of approximately 1/8" (3mm) off the flange surface of the tub deck, shower base and walls. Press panel firmly over entire surface to ensure firm contact of panel to adhesive on wall.

NOTE: It may be necessary to brace or support the panels against the wall until the panels stay securely in place. (See Illustration 6)

STEP 4

- Apply panel adhesive as in Step 2 for second panel. Place second rear panel on wall and allow 1/8" separation from the groove of the first panel and the tongue of the second panel, keeping approximately 1/8" (3mm) gap between bottom of tub deck, shower base, wall and tub flange.
- Apply color coordinated sealant to the tongue of the second panel. Gently close the seam area, do not force or tap the groove edge to close the joint. Press firmly over entire area of panel to securely hold in place. Wipe excessive adhesive that comes out between the tongue and groove with denatured alcohol.

STEP 5

- Apply side panels in the same manner keeping the finished reveal edge to the outside or entrance of the tub or shower pan using the same adhesive pattern. Provide a gap of approximately 1/8" (3mm) in the corners between the side and rear panels to accommodate adhesive. Wipe off any excessive adhesive with denatured alcohol.

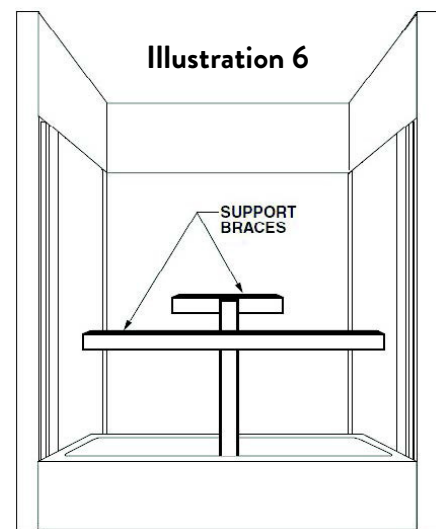

COLOR COORDINATED SEALANT APPLICATION

Mermaid Installation

Applying Color Coordinated Sealant For Seams and Joints

NOTE: Color coordinated sealant is colored or matched to the approximate color of panel being installed. This helps ensure sealant is not as visible.

STEP 1

- Once all panels are securely in place and set, apply the color coordinated sealant to all corners, seams between panels and gaps between bottom panels and tub or shower pan (See Illustration 7).

NOTE: Wipe any excess adhesive from the panel with denatured alcohol .

STEP 2

- Allow panels to cure for 24 hours before installation of shower accessories.

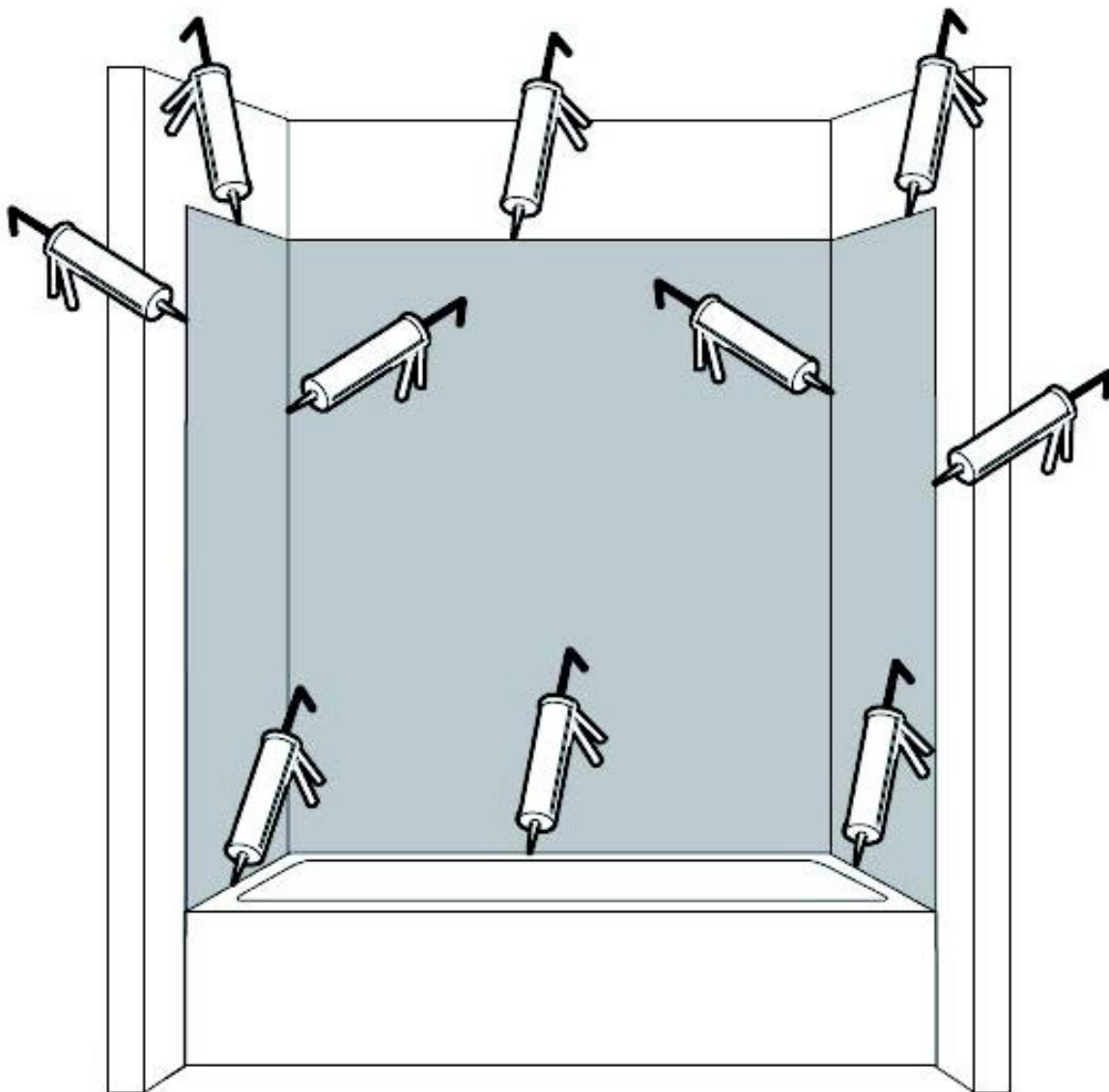

Illustration 7

ACCESSORY INSTALLATION

Installing Shower Heads, Bath Spouts, Handles/Grab Bars, and Niches

NOTE: Color coordinated sealant is colored or matched to the approximate color of panel being installed. This helps ensure sealant is not as visible.

STEP 1

- Install the shower accessories per the manufacturer's instructions. Be sure to apply color coordinated sealant to all trim plates.
- Prior to installing Mermaid panels, customers must create the needed structural framing to anchor grab bars and niches directly to the stud wall.
- Review and follow all local and federal load requirements for grab bars, the screws will need to penetrate the Mermaid panel into the stud. Then you can apply color coordinated sealant over the threads of mounting screws to ensure a clean install.
- Just a reminder, Mermaid itself must not support the weight of any accessories.

NOTE: Drilled or hole-saw holes for mechanical fasteners must be oversized in the Mermaid panel.

NOTE: Allow 24 hours for the color coordinated sealant to dry before use.

Installing Shower Shelves, Doors and Curtain Rods

FOLLOW MANUFACTURER'S INSTRUCTIONS

IMPORTANT: Apply color coordinated sealant over the threads of mounting screws AND around outside of each wall anchor to seal out moisture and water. The shelf/shelves must be supported to the wall behind the Mermaid panel. Mermaid panels itself must not support the weight of the shelf/shelves.

INSTALLATION CLEAN-UP

- Install the shower accessories per the manufacturer's instructions. Be sure to apply color coordinated sealant to all trim plates.
- Prior to installing Mermaid Panels, customers must create the needed structural framing to anchor grab bars and niches directly to the stud wall.
- Review and follow all local and federal load requirements for grab bars, the screws will need to penetrate the Mermaid panel into the stud. Then you can apply color coordinated sealant over the threads of mounting screws to ensure a clean install.
- Just a reminder, Mermaid itself must not support the weight of any accessories.

NOTE: Drilled or hole-saw holes for mechanical fasteners must be oversized in the Mermaid panel.

NOTE: Allow 24 hours for the color coordinated sealant to dry before use.

Installing Shower Shelves, Doors and Curtain Rods

CARE AND MAINTENANCE



IMPORTANT: Apply color coordinated sealant over the threads of mounting screws AND around outside of each wall anchor to seal out moisture and water. The shelf/shelves must be supported to the wall behind the Mermaid panel. Mermaid itself must not support the weight of the shelf/shelves.

- Warm soapy water and a sponge will be adequate for regular maintenance.
- Common non-abrasive household cleaners can be used with a soft sponge or cloth. It is recommended that all cleaners should be rinsed immediately.
- Recommended cleaners: Lime-A-Way® Cleaner, Mr. Clean® MagicEraser, Tilex® Bathroom Cleaner
- Fabuloso® All-Purpose Cleaner, Fantastik® All-Purpose Cleaner, Windex® Multi-Surface Cleaner,
- Formula 409® Multi-Surface Cleaner, Simple Green® All-Purpose Cleaner, Pine-Sol® Multi-Surface Cleaner, Green Works® All-Purpose Cleaner, Spic and Span® Liquid Multi-Surface & Floor Cleaner.
- Do not use wire brushes, knives or sharp objects to remove stains, cigarette tar deposits, or other surface blemishes.
- Abrasive cleaners or powders must not be used, since they will dull the surface. Do not use Gritty Cleaners, Scotch-Brite™ Pads, Comet® Bleach Powder or Soft Cleanser, Strong Solvents (Thinners, MEK).
- If bleach is used, dilute 1/4 cup of bleach to 1 gal of water is recommended. Rinse immediately as prolonged exposure of bleach on the surface will cause discoloration.